

KENIA-90 VISION



SDC	SCL	SSV								14
73	4,7	350			124	200	2x120	2x160	760x265x335	72
M-19 M-20 M-27 M-28										

Características

- Sistema de Doble Combustión
- Sistema de Cristal Limpio
- Sistema de Seguridad en los Ventiladores
- Potencia calorífica: 14kw
- Rendimiento (%): 73%
- Consumo (kg/h): 4,7kg/h
- Volumen calefactable (m3): 350m3
- Interior Cerámico
- Elaborado en Chapa
- Peso (kg): 124kg
- Diámetro salida de humos (mm): 200mm
- Canalizable (n° x Ø): 2x120
- Ventilación forzada (n° x m3): 2x160
- Boca útil cámara (mm): 760x265x335mm
- Tamaño máx. troncos (cm): 72cm
- Accesorios compatibles no incluidos: M-19; M-20; M-27; M-28

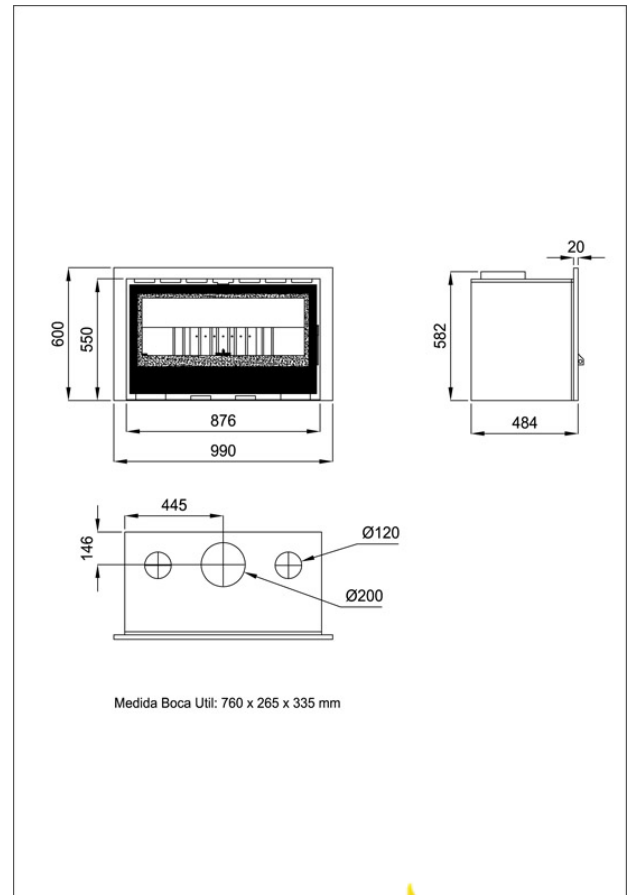

Dada la continua mejora de nuestros productos y el perfeccionamiento de nuestro proceso de fabricación, las dimensiones, la estética del producto y las características técnicas están sujetas a posibles variaciones sin previo aviso por parte de nuestra empresa.

www.bronpi.com

