













SORIA



 SDC	 SCL	 SBE						 kW
 75	 3,7	 300			 385x285x270		 12	

Features

- Double Combustion System
- Clean Glass System
- Low Emissions System
- Heating power: 12kw
- Efficiency (%): 75%
- Consumption (kg/h): 3,7kg/h
- Heating capacity (m3): 300m3
- Vermiculite inside
- Manufactured in cast-iron and sheet
- Weight (kg): 56kg
- Smoke exit tube diameter (mm): 150mm
- Useful chamber measures: 385x285x270mm
- Maximum logs size (cm): 45cm

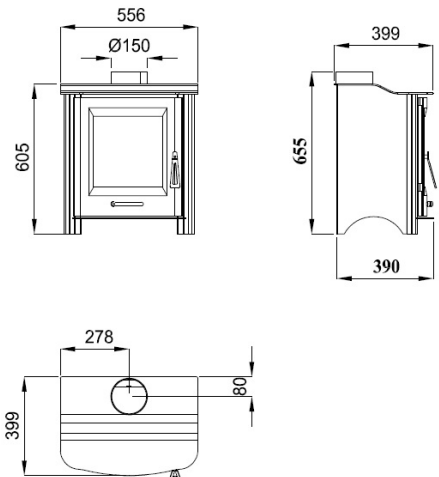

Given the continued improvement of our products and improving our manufacturing process, size, aesthetics and product specifications are subject to change without prior notice from our company.

www.bronpi.com

