















# OXFORD

©Bronpi Calefacción, S.L. reserves all rights to the images that appear in this document. You may not reproduce or distribute part or all of the photographs and as the text. Both the brand as distinctive symbols are the exclusive property of the company. Violators will be prosecuted according to law.



 SDC	 SCL	 SLC								 kW
 4,6	 81	 78	 1,3	 0,75	 115			 51	 150	 275x260x270
 30										

## Features

- Double Combustion System
- Clean Glass System
- Multifuel System
- Heating power: 4,6kw
- Coal power: 4,6kw
- Efficiency (%): 81%
- Coal efficiency (%): 78%
- Consumption (kg/h): 1,3kg/h
- Coal consumption (kg/h): 0,75kg/h
- Heating capacity (m3): 115m3
- Vermiculite inside
- Manufactured in cast-iron and steel
- Weight (kg): 51kg
- Smoke exit tube diameter (mm): 150mm
- Useful chamber measures: 275x260x270mm
- Maximum logs size (cm): 30cm

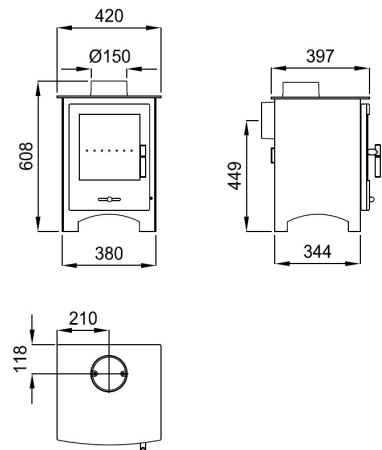

Given the continued improvement of our products and improving our manufacturing process, size, aesthetics and product specifications are subject to change without prior notice from our company.

[www.bronpi.com](http://www.bronpi.com)

